

zehnder

always the
best climate

Always the best climate for

SMART BUILDINGS

Zehnder ComfoAir Q ventilation units



SIMPLE PLANNING

Easy planning, installation and commissioning saves time and ensures that the system works perfectly.



PAGE 4-5

BETTER ENERGY EFFICIENCY

Innovative technologies guarantee a perfect living situation for your customers with the performance standards of tomorrow.

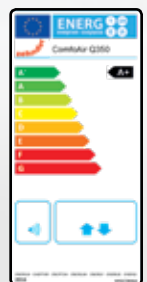

PAGE 6-7

Zehnder ComfoAir Q: creating comfort for maximum customer satisfaction

Your customers expect the highest standards, maximum comfort and maximum energy efficiency. But it's not just your customers who have significant demands to meet – legislation does too. With Zehnder indoor ventilation and the new, intelligent Zehnder ComfoAir Q* comfort ventilation units, an innovative and flexible overall system that is the ideal solution for all of these requirements is now on hand.

Zehnder ComfoAir Q comfortably meets the legal regulations that apply within Europe, as well as providing a reliable way of complying with future energy standards. The ventilation unit increases the well-being effect for your customers with innovative functions and sustainable options such as heat recovery. And thanks to a simple, flexible installation concept, perfect integration into building control systems and professional support from Zehnder, nothing can go wrong during planning and installation.

* Successor generation to Zehnder ComfoAir 350 and 550.

MORE LIVING COMFORT

The Zehnder ComfoAir Q ventilation unit has come up with various innovative ways to maximise the well-being effect for your customers.



PAGE 8–9

PERFECT INTEGRATION

With perfectly matched system expansions and air distribution components, Zehnder ComfoAir Q can be integrated harmoniously into the Zehnder overall system for comfortable indoor ventilation.



PAGE 10–11

Save time and effort thanks to easy planning and installation

Zehnder supports you along every step of your project planning process. The result is a top-quality system and satisfied customers. All units and components from our complete system are compatible with one another and can be provided with BIM data, making everything as easy as possible for you. The revised design and innovative technologies of Zehnder ComfoAir Q are guaranteed to save you time during installation and avoid stress during commissioning – and the system runs without a hitch. With a KNX connection, integrating Zehnder ComfoAir Q into a building management is simple. Our user-friendly planning tool provides you with support during the process of configuring your ideal ventilation system. All relevant technical data is available to you at www.ComfoAirQ.com.

VARIOUS CONTROL OPTIONS

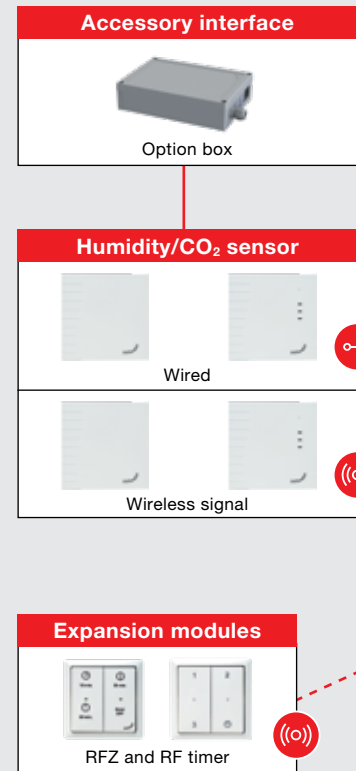

SUITABLE FOR ALL INSTALLATION SITUATIONS



Zehnder ComfoAir Q TR



Zehnder ComfoAir Q ST

- With air volumes of 350, 450 and 600 m³/h
- Plug-and-play connections can be changed from right to left if installation situations change

- Suitable for single occupancy and multiple-family houses, offices and commercial buildings

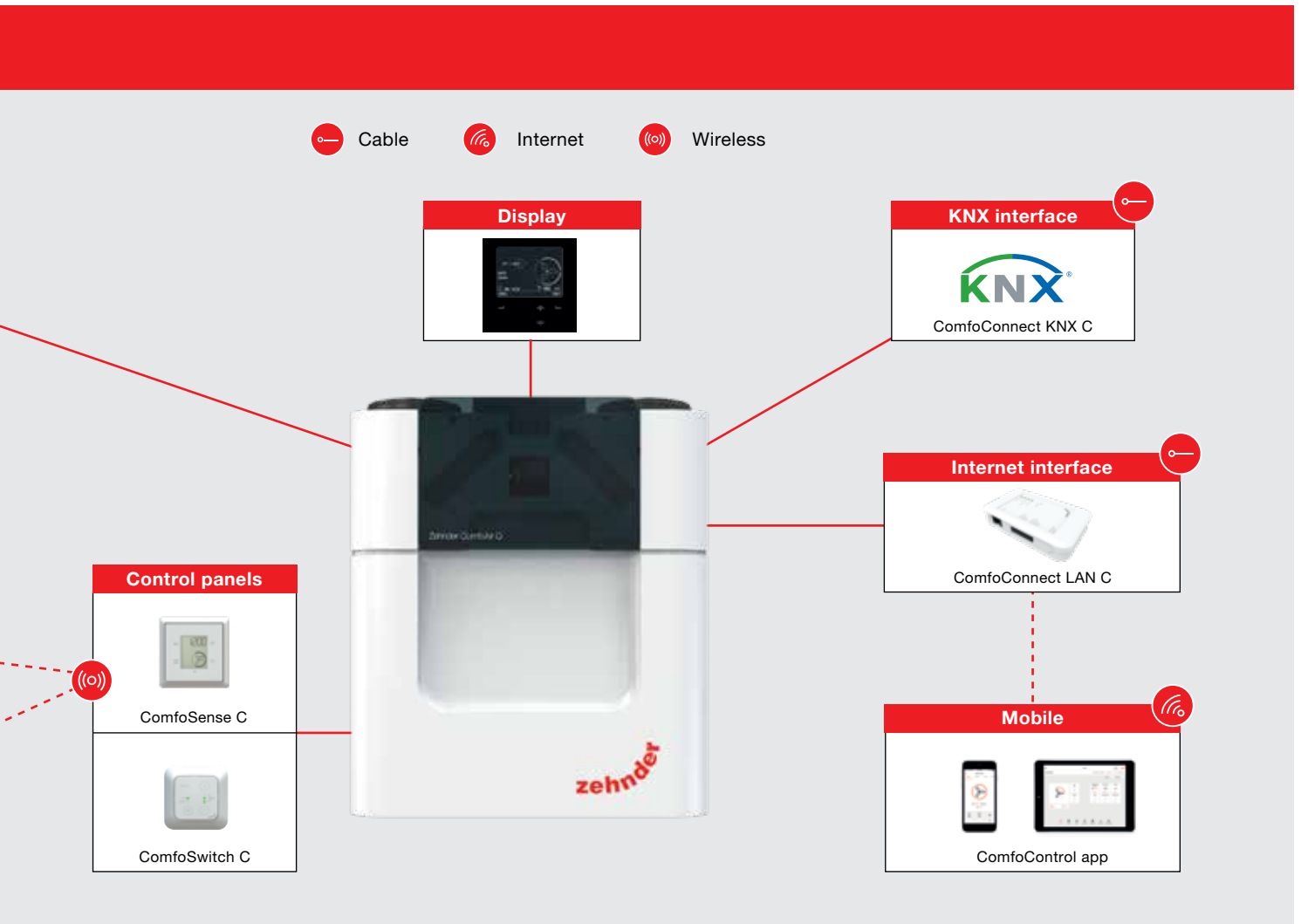

EASY OPERATION FROM SWITCH TO APP



- Simple performance monitoring
- Easy maintenance that can also be monitored remotely

EASY TO DOWNLOAD BIM DATA



- Improved planning options thanks to visualisation
- More control over the result of the installation
- Lower costs thanks to an efficient building process
- Reliable, convenient building process thanks to uniform data exchange

Comfortably meeting the energy standards of tomorrow

To meet legal requirements, planners require state-of-the-art technologies that offer maximum potential for energy saving. Zehnder ComfoAir Q models not only meet the current European standards with regard to their properties in the three areas of power consumption, level of efficiency and control – they even go above and beyond the requirements for 2018. Thanks to its innovative technologies, Zehnder ComfoAir Q offers the highest energy efficiency¹⁾ and the lowest energy consumption in its class. All of this helps you to plan buildings with maximum comfort and energy efficiency in a future-proof way.



The best energy efficiency class is A+²⁾ for Zehnder comfort ventilation units

¹⁾ Using the PHI measuring method, 90% heat recovery with an SFP of 0.28/Watt/m³/h at 270 m³/h.

²⁾ Depending on the control unit/sensor technology chosen.

For detailed information, visit www.ComfoAirQ.com

+ ADVANTAGE

Because of its high rate of heat recovery, Zehnder ComfoAir Q reduces the heat load by 38%, compared to the average of competitor products. This means you can provide heat over three winters for the price of two!

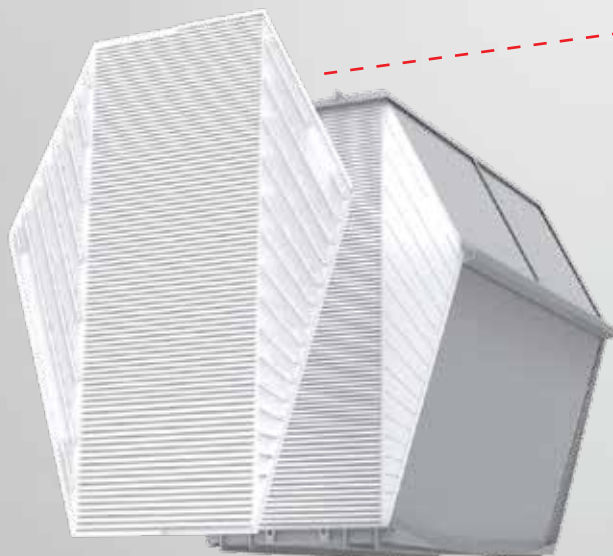

Unique, ultra-powerful heat exchanger – for maximum energy efficiency

The unique Paul diamond heat exchanger features an especially large surface, which allows it to achieve a higher level of efficiency. Variable duct heights ensure a constant flow and lower pressure loss. As a result, less energy is required to overcome the air resistance.



Innovative air volume balancing – for maximum heat recovery

New and patented: the innovative sensor technology automatically ensures balanced supply air and extract air volumes. This Flow Control guarantees maximum heat recovery. What's more, you save time during commissioning because there is no need to adjust the speed manually and the air volumes are balanced automatically.

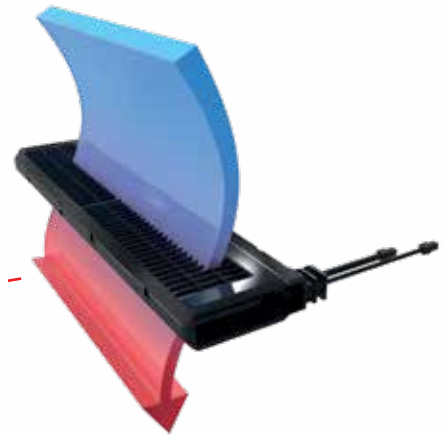
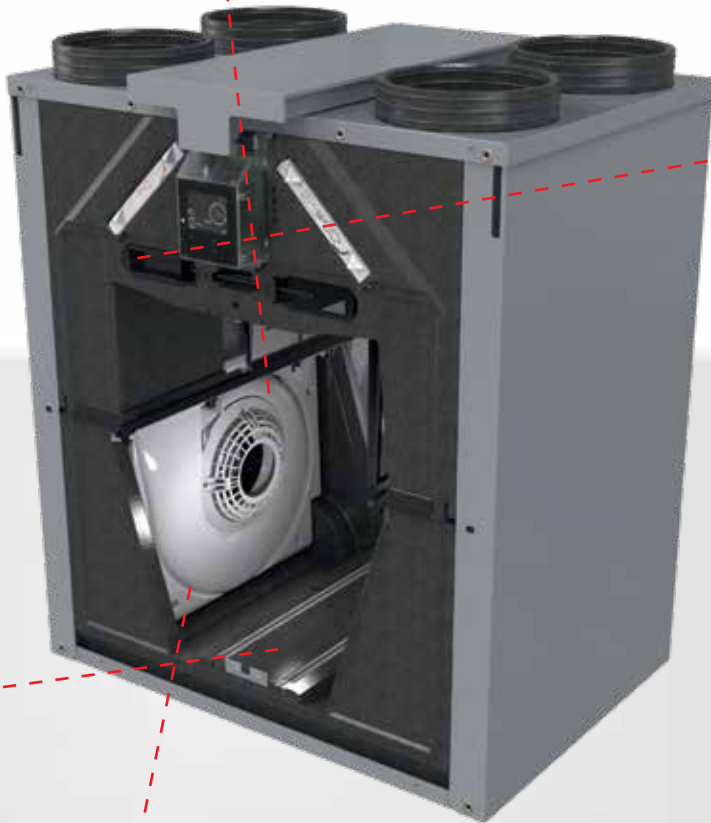

Intelligent temperature control of the drawn-in outdoor air – for the best possible energy efficiency

The adaptive pre-heater adapts perfectly to the temperature, volume flow and air humidity, and provides the outside air temperature required for energy-efficient operation no matter the temperature outside. Thanks to its large surface and delta shape, the level of pressure loss is negligible – and that also reduces the power consumption.



State-of-the-art fan technology – for quiet, energy-saving operation

The flow grid, scroll housing and ebmpapst RadiCal impeller ensure the best possible air flow. This guarantees not only extremely quiet operation, but also particularly low power consumption. A high-quality, future-proof solution, based on tried-and-tested technology.

Healthy, pollen-free air thanks to innovative technologies

Fresh air is vital for our health. Scientific studies prove that there is a direct relationship between our performance and well-being, and a regulated fresh air supply. In modern houses where insulation is getting better and better, we can no longer guarantee the natural air exchange.

This is where we need a ventilation system which has optimum dimensions and which ensures a constant supply of fresh air in all internal spaces. Thanks to optimised filter concepts, it ensures a healthy air supply that is free from both dust and pollen. What's more, optional CO₂ sensors make it possible to monitor the air quality constantly.

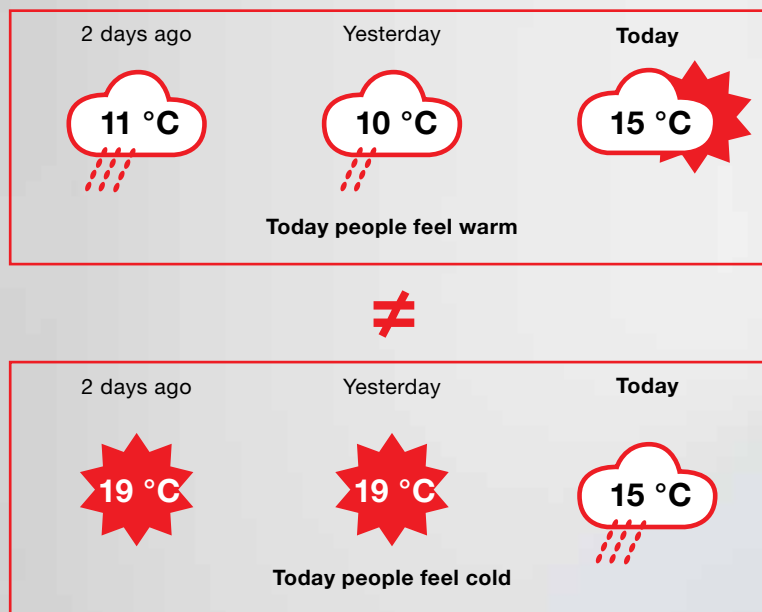

Optimised supply air temperatures

- Comfort technology for temperature management in line with temperature and humidity changes
- Modulating by-pass for controlled supply air temperatures in all seasons
- Integrated humidity and temperature sensors

Comfort temperature optimised for the season

- Adaptive climate technology that factors in the differing temperature perception according to the season ensures very pleasant room temperatures.

Comfortable indoor ventilation systems contain sophisticated technology and provide your customers with many advantages. Innovative technologies in heat exchangers and fans make these units the quietest on the market. Intelligent control units and controllers ensure that your customers are able to enjoy the best climate in any situation.

Simple solutions, such as apps, guarantee flexible and reliable operation of indoor ventilation, delivering an ideal climate that contributes significantly to quality of life.



The quietest indoor ventilation of its class

- Innovative fans, control units and heat exchangers for low noise levels
- Zehnder ComfoFresh air distribution system with low air resistance

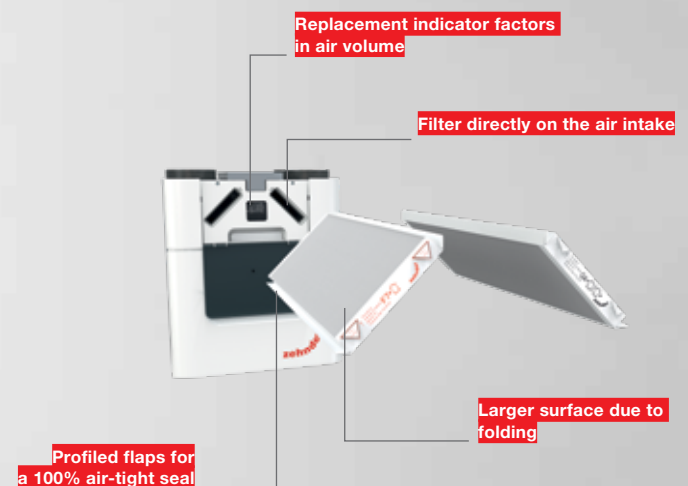

Optimum hygiene thanks to effective filter concept

- No dust gets into the room air
- Filters are up to 100% sealed, with a maximised surface
- Warning indicator showing when it is time to replace the filter, keeping air healthy
- Standards G4 and F7 met

Enjoy more planning freedom thanks to a perfect overall system

Zehnder gives planners maximum freedom. Whether the project involves a single-family house or an apartment, a new build or renovation work, we always have the right solution for almost effortless installation. We offer all the products and accessory components to create a complete ventilation system, meaning that you can bring all your concepts to life. The Zehnder overall system is made up of an innovative ventilation unit, an air distribution system comprising compatible components, plus intelligent control units as well as optional ground source heat exchangers and pre-cooling options. The components are clearly organised and easy to select. It is easy to integrate into any building management system thanks to its KNX field bus.



+ OPTIONAL

Zehnder ComfoFond-L Q sub-soil heat exchanger

- Easily and sustainably uses geothermal energy
- Pre-heated outdoor air in winter
- Tempered outdoor air in summer
- Saves energy by using renewable energy from the ground



Zehnder ComfoAir Q comfort ventilation unit

- Complete range available in various air volumes: 350, 450 and 600 m³/h
- Suitable for single occupancy and multiple-family houses, office/commercial buildings in new builds or renovations
- Various control and operating options

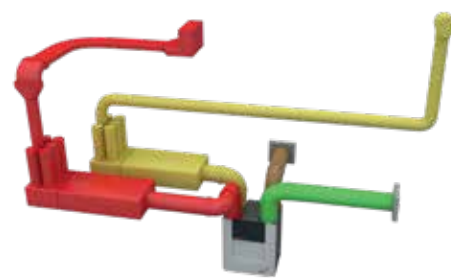

Zehnder ComfoFresh air distribution system

- The air distribution system can be incorporated into ceilings, walls and floors using round tubes, flat tubes, or a combination of the two – a sophisticated system for any situation
- Perfectly matched components for every installation situation
- ComfoPipe outdoor and exhaust air connections with optimum insulation
- Designer grille for harmonious integration into any setting

+ OPTIONAL

Pre-tempering with Zehnder ComfoCool Q

- Tempers and dehumidifies outdoor air
- Fresh air and the right temperature in any season
- Pleasant tempering of the air on hot days
- In combination with ComfoAir Q 600 ST





FAQ

What do I need to consider when planning?

Three ventilation units are available, each with a different air volume: 350, 450 and 600 m³/h. As a result, you can design a ventilation system to suit your project perfectly. Sudden changes to the original plans as far as connectors are concerned are no problem at all, because the Zehnder ComfoAir Q design incorporates the right-hand and left-hand version in the same unit.

Who can I contact if I have any questions?

Whether during the planning phase or on site, our customer service department is available to provide you with support and expertise in any situation. Even on site, our employees are happy to give advice if you have any questions relating to the planning and installation of Zehnder ventilation systems. We promise to provide you with Zehnder's full support for every challenge and also a contact, who will assess the situation with you personally.

Does this mean I will also be up-to-date with future energy saving requirements?

Zehnder ComfoAir Q has been awarded or applied for all the relevant energy efficiency certificates. In fact, the ventilation unit actually exceeds the current European energy saving requirements. Zehnder ComfoAir Q is currently the market leader in its class, particularly when it comes to heat recovery. This means that the ventilation unit is the most future-proof solution that you can offer your customers.

Why should I recommend Zehnder ComfoAir Q to my customers?

Zehnder ComfoAir Q is the best possible solution when it comes to energy efficiency and the well-being effect. The ventilation unit makes an important contribution to comfortable fresh air, is practically silent during operation and offers the right operating solution to suit every need – from the display, to the ComfoControl app, right through to fully automated, demand-based ventilation by means of sensors.

Zehnder ComfoAir Q350 TR²

Qv [m ³ /h]	Pst [Pa]	P [W]	L _w ¹ Supply air [dB(A)]	L _w ¹ Extract air [dB(A)]	L _w ¹ Unit emission [dB(A)]
150	25	13	46	35	34
200	50	30	51	38	38
245	50	42	54	41	41
250	100	58	56	43	43
300	100	77	59	46	46
350	100	100	62	48	49
250	150	71	58	45	45
250	200	85	61	47	47
300	200	106	63	49	49
350	200	131	66	51	52

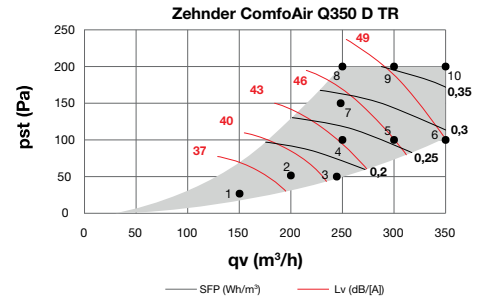

Zehnder ComfoAir Q450 TR²

Qv [m ³ /h]	Pst [Pa]	P [W]	L _w ¹ Supply air [dB(A)]	L _w ¹ Extract air [dB(A)]	L _w ¹ Unit emission [dB(A)]
200	25	17	52	42	39
250	50	37	56	44	42
300	50	55	58	46	45
315	50	61	59	46	45
350	100	94	62	48	48
400	100	121	64	50	51
450	100	152	67	52	53
350	150	110	63	49	49
350	200	127	64	50	51
400	200	156	67	51	53
450	140	166	68	52	54

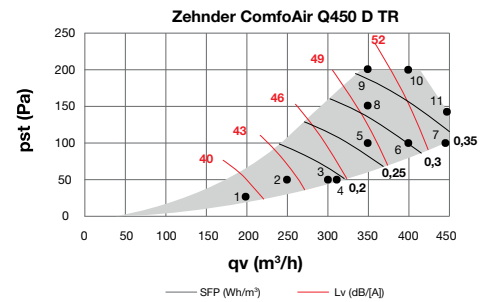

Zehnder ComfoAir Q600 ST²

Qv [m ³ /h]	Pst [Pa]	P [W]	L _w ¹ Supply air [dB(A)]	L _w ¹ Extract air [dB(A)]	L _w ¹ Unit emission [dB(A)]
250	25	21	54	43	43
300	25	36	56	45	45
350	50	64	59	48	48
400	50	87	62	50	50
420	50	98	63	51	51
450	100	134	65	53	53
500	100	166	68	55	55
600	100	243	73	59	60
450	150	153	66	53	54
450	200	173	67	54	55
500	200	207	70	56	57
600	200	287	75	60	61

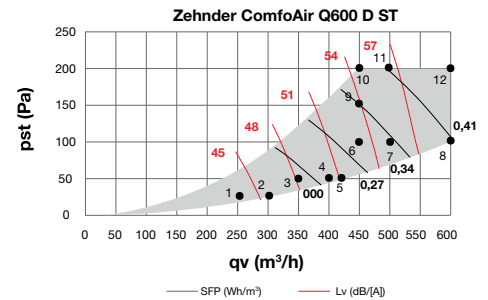

L_w in dB(A) reference 10⁻¹²W, SFP [w/(m³/h)] calculated using data measured in accordance with EN 13141-7: 2010, ¹L_w in dB(A); sound, supply air/extract air measured in accordance with ISO 3741 including end reflection in accordance with EN 13053:2006, ²Zehnder ComfoAir Q with G4/G4 filter and pre-heater

Zehnder ComfoAir Q ST

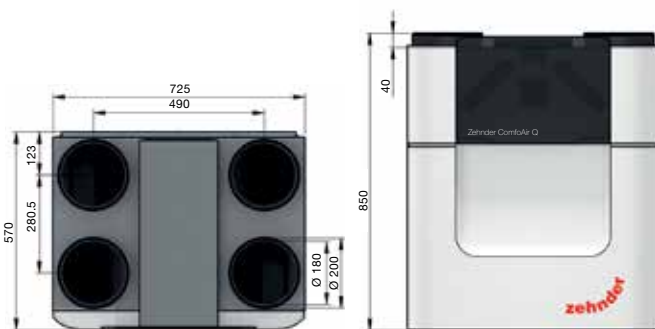

Top

Front

Zehnder ComfoAir Q TR

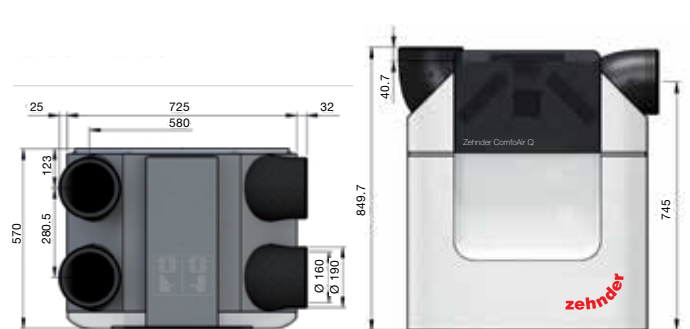

Top

Front

